



SPEED

 **SPEED China**

JIANGMEN SPEED STAINLESS STEEL PRODUCT CO., LTD.

R&D · Handmade Sink · Drawn Sink · Sink Accessories

 **SPEED Vietnam**

VIETTA INDUSTRIES (VN) CO., LTD. *Handmade Sink*

SPEED SINKWARE (VN) CO., LTD. *Drawn Sink*

<http://www.speed-vietnam.com>

Email: speed@speedsink.com

拉伸水槽-国际
Premium Drawn sinks / International 2021

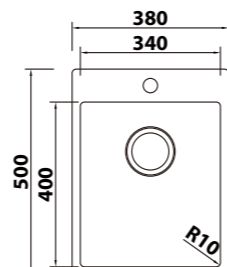
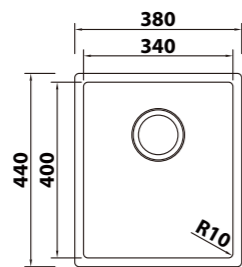

PS34SA

- ▶ 水槽尺寸: 380 x 440 x 200mm
- ▶ 厚度: 1.0mm
- ▶ 材质: SUS304

PST34SA

- ▶ 水槽尺寸: 380 x 500 x 200mm
- ▶ 厚度: 1.0mm
- ▶ 材质: SUS304



1

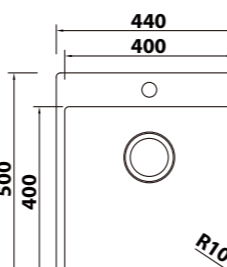
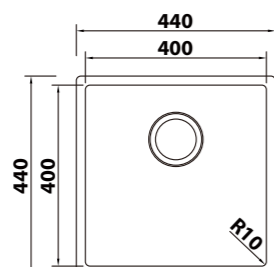
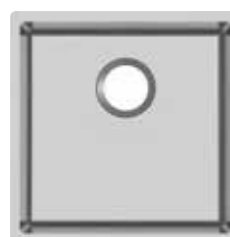

PS40SA

- ▶ 水槽尺寸: 440 x 440 x 200mm
- ▶ 厚度: 1.0mm
- ▶ 材质: SUS304

PST40SA

- ▶ 水槽尺寸: 440 x 500mm x 200mm
- ▶ 厚度: 1.0mm
- ▶ 材质: SUS304



2

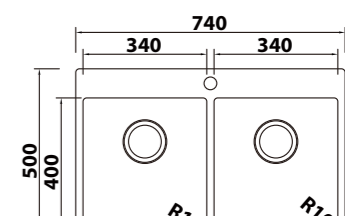
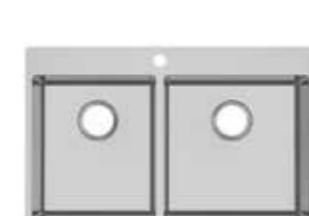
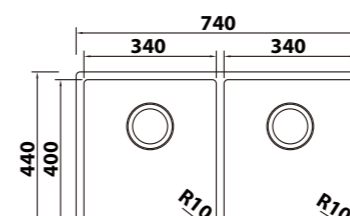
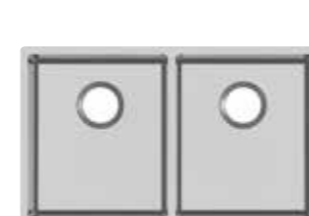

PS3434DA

- ▶ 水槽尺寸: 740 x 440 x 200mm
- ▶ 厚度: 1.0mm
- ▶ 材质: SUS304

PST3434DA

- ▶ 水槽尺寸: 740 x 500 x 200mm
- ▶ 厚度: 1.0mm
- ▶ 材质: SUS304

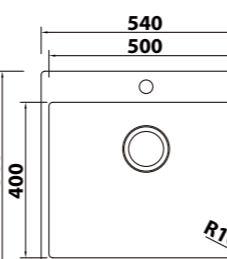
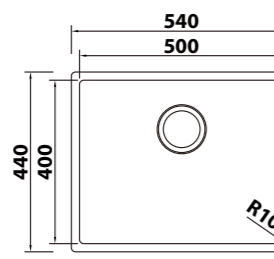
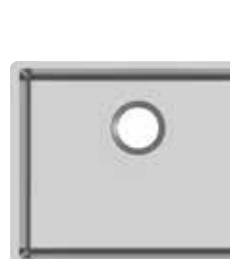

PS50SA

- ▶ 水槽尺寸: 540 x 440 x 200mm
- ▶ 厚度: 1.0mm
- ▶ 材质: SUS304

PST50SA

- ▶ 水槽尺寸: 540 x 500 x 200mm
- ▶ 厚度: 1.0mm
- ▶ 材质: SUS304

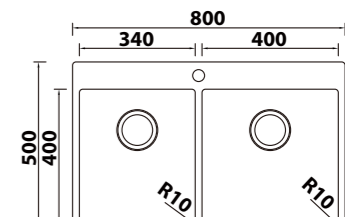
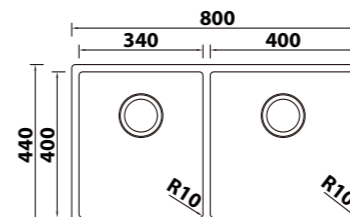

PS3440DA

- ▶ 水槽尺寸: 800 x 440 x 200mm
- ▶ 厚度: 1.0mm
- ▶ 材质: SUS304

PST3440DA

- ▶ 水槽尺寸: 800 x 500 x 200mm
- ▶ 厚度: 1.0mm
- ▶ 材质: SUS304

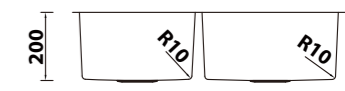
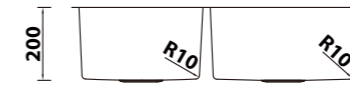

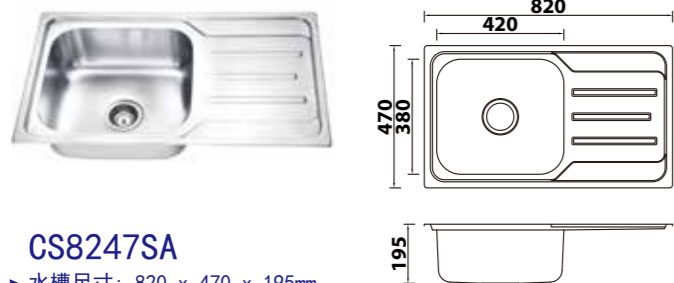

CS8247SA

- ▶ 水槽尺寸: 820 x 470 x 195mm
- ▶ 厚度: 0.8mm
- ▶ 材质: SUS304

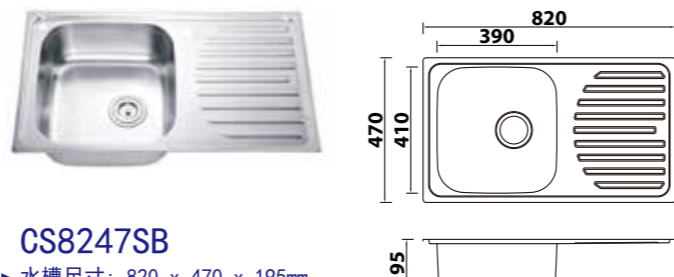

CS8247SB

- ▶ 水槽尺寸: 820 x 470 x 195mm
- ▶ 厚度: 0.8mm
- ▶ 材质: SUS304



CS430SA

- ▶ 水槽尺寸: Ø428 x 185mm
- ▶ 厚度: 0.7-0.9mm
- ▶ 材质: SUS304

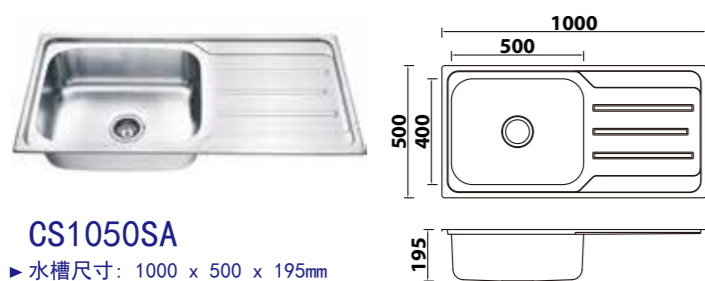

CS1050SA

- ▶ 水槽尺寸: 1000 x 500 x 195mm
- ▶ 厚度: 0.8mm
- ▶ 材质: SUS304

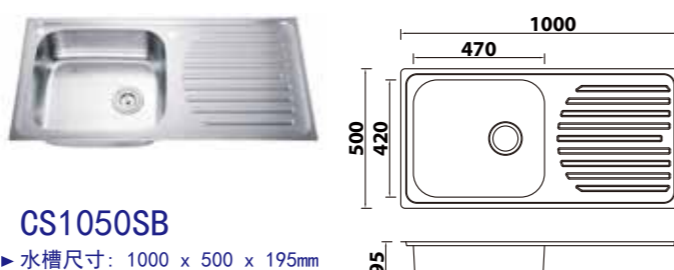

CS1050SB

- ▶ 水槽尺寸: 1000 x 500 x 195mm
- ▶ 厚度: 0.8mm
- ▶ 材质: SUS304



CS480SA

- ▶ 水槽尺寸: Ø480 x 185mm
- ▶ 厚度: 0.8mm
- ▶ 材质: SUS304



CS510SA

- ▶ 水槽尺寸: Ø510 x 185mm
- ▶ 厚度: 0.8mm
- ▶ 材质: SUS304

3

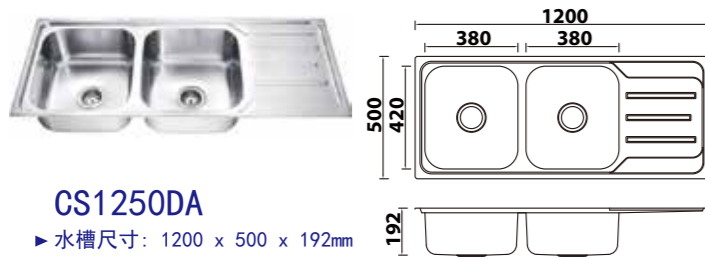

CS1250DA

- ▶ 水槽尺寸: 1200 x 500 x 192mm
- ▶ 厚度: 0.8-1.0mm
- ▶ 材质: SUS304

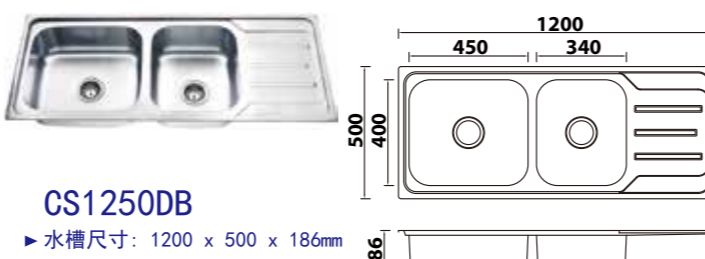

CS1250DB

- ▶ 水槽尺寸: 1200 x 500 x 186mm
- ▶ 厚度: 0.8-1.0mm
- ▶ 材质: SUS304

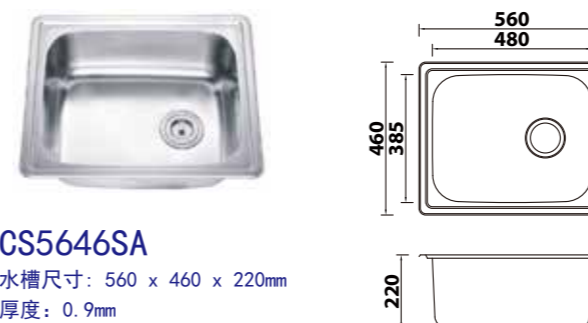

CS5646SA

- ▶ 水槽尺寸: 560 x 460 x 220mm
- ▶ 厚度: 0.9mm
- ▶ 材质: SUS304



CS7845SA

- ▶ 水槽尺寸: 780 x 490 x 200mm
- ▶ 厚度: 0.9mm
- ▶ 材质: SUS304

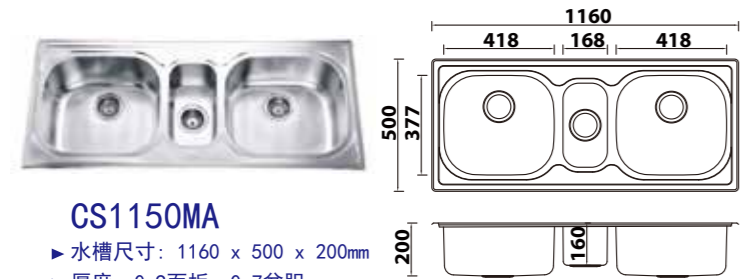

CS1150MA

- ▶ 水槽尺寸: 1160 x 500 x 200mm
- ▶ 厚度: 0.9面板, 0.7盆胆
- ▶ 材质: SUS304

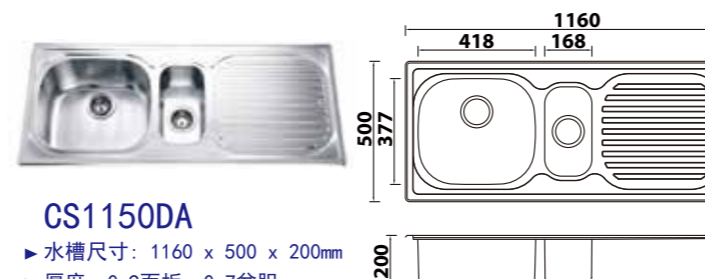

CS1150DA

- ▶ 水槽尺寸: 1160 x 500 x 200mm
- ▶ 厚度: 0.9面板, 0.7盆胆
- ▶ 材质: SUS304



CS6045SA

- ▶ 水槽尺寸: 600 x 450 x 210mm
- ▶ 厚度: 0.8mm
- ▶ 材质: SUS304



4



5

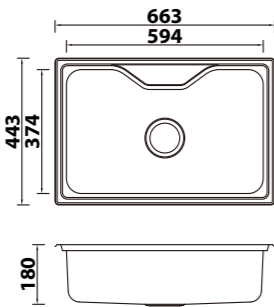

CS6644SA

- ▶ 水槽尺寸: 663 x 443mm x 180mm
- ▶ 厚度: 0.9mm
- ▶ 材质: SUS304

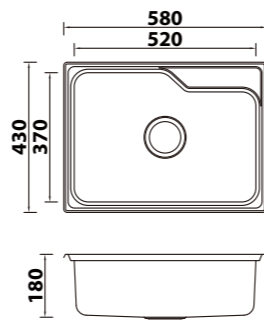

CS5843SA

- ▶ 水槽尺寸: 580 x 430 x 180mm
- ▶ 厚度: 0.7-0.9mm
- ▶ 材质: SUS304

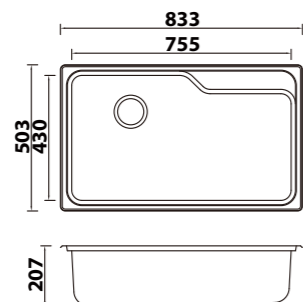

CS8350SA

- ▶ 水槽尺寸: 833 x 503 x 207mm
- ▶ 厚度: 0.9mm
- ▶ 材质: SUS304

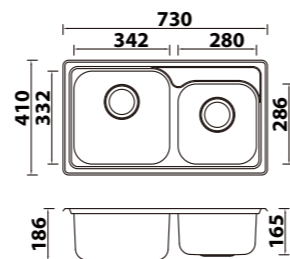

CS7341DA

- ▶ 水槽尺寸: 730 x 410 x 186mm
- ▶ 厚度: 0.9mm
- ▶ 材质: SUS304

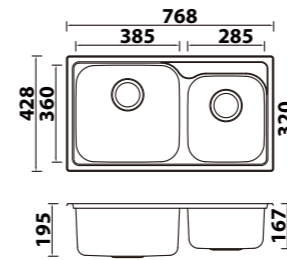

CS7642DA

- ▶ 水槽尺寸: 768 x 428 x 195mm
- ▶ 厚度: 0.9mm
- ▶ 材质: SUS304

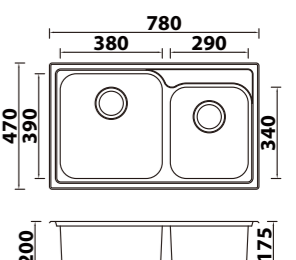

CS7847DA

- ▶ 水槽尺寸: 780 x 470 x 200mm
- ▶ 厚度: 0.9mm
- ▶ 材质: SUS304

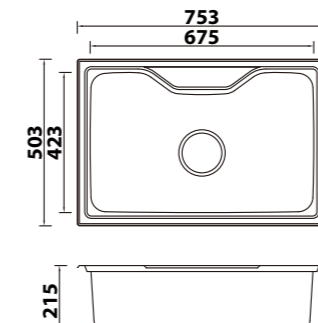

CS7550SA

- ▶ 水槽尺寸: 753 x 503 x 215mm
- ▶ 厚度: 0.7-0.9mm
- ▶ 材质: SUS304

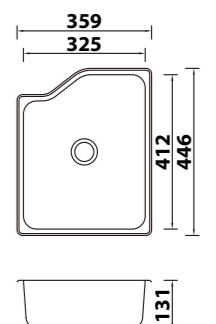

BT002

- ▶ 水槽尺寸: 359 x 446 x 131mm
- ▶ 厚度: 0.7-0.9mm
- ▶ 材质: SUS304

6



7



CS6045SB

- ▶ 水槽尺寸: 600 x 450 x 250mm
- ▶ 厚度: 0.9mm
- ▶ 材质: SUS304

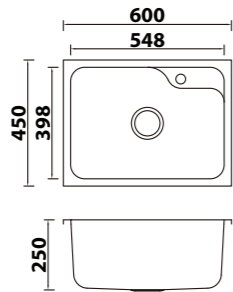

CS8245DA

- ▶ 水槽尺寸: 827 x 457mm x 200mm
- ▶ 厚度: 0.9mm
- ▶ 材质: SUS304

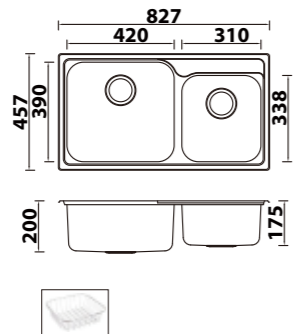

CS8645DA

- ▶ 水槽尺寸: 864 x 454mm x 195mm
- ▶ 厚度: 0.9面板, 0.7盆胆
- ▶ 材质: SUS304

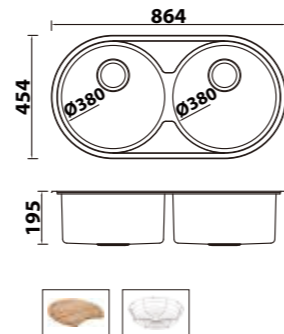

CS8549DA

- ▶ 水槽尺寸: 850 x 490mm x 200mm
- ▶ 厚度: 0.9mm
- ▶ 材质: SUS304

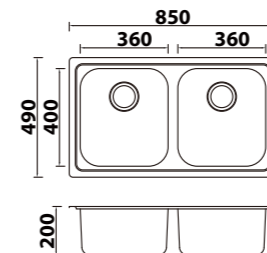

CS8446DA

- ▶ 水槽尺寸: 840 x 460mm x 180mm
- ▶ 厚度: 0.9mm
- ▶ 材质: SUS304

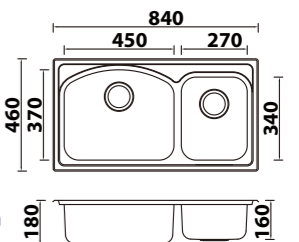

8



CS3337SA

- ▶ 水槽尺寸: 337 x 377 x 160mm
- ▶ 厚度: 0.7-0.9mm
- ▶ 材质: SUS304

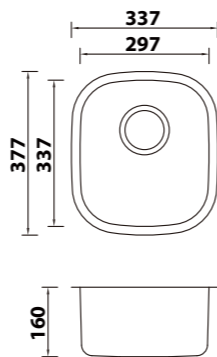

CS3935SA

- ▶ 水槽尺寸: 350 x 390 x 160mm
- ▶ 厚度: 0.7-0.9mm
- ▶ 材质: SUS304

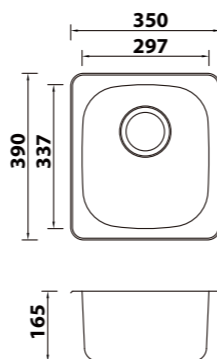

CS4238SA

- ▶ 水槽尺寸: 380 x 420 x 175mm
- ▶ 厚度: 0.7-0.9mm
- ▶ 材质: SUS304

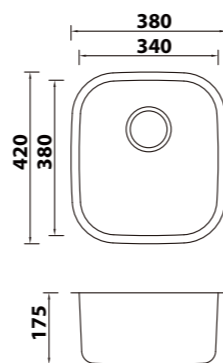

CS4642SA

- ▶ 水槽尺寸: 458 x 417mm x 185mm
- ▶ 厚度: 0.7-0.9mm
- ▶ 材质: SUS304

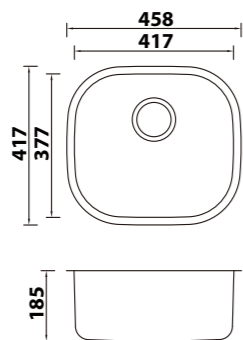

CS4642SB

- ▶ 水槽尺寸: 465 x 422 x 180mm
- ▶ 厚度: 0.7-0.9mm
- ▶ 材质: SUS304

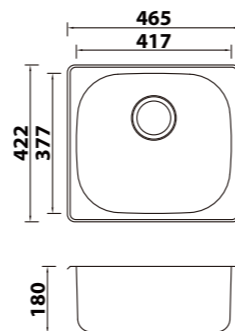

CS3442SA

- ▶ 水槽尺寸: 348 x 428 x 185mm
- ▶ 厚度: 0.9-1.2mm
- ▶ 材质: SUS304

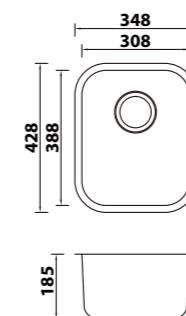

CS3946SA

- ▶ 水槽尺寸: 395 x 468 x 220mm
- ▶ 厚度: 1.2mm
- ▶ 材质: SUS304

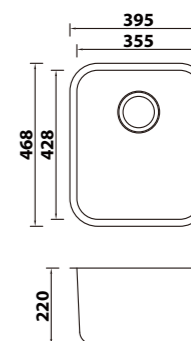

CS5344SA

- ▶ 水槽尺寸: 440 x 530 x 240mm
- ▶ 厚度: 1.2mm
- ▶ 材质: SUS304

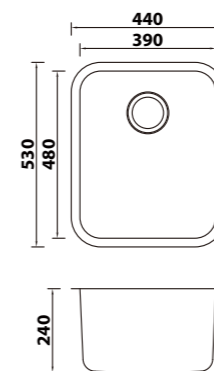

CS5751SA

- ▶ 水槽尺寸: 570 x 516 x 240mm
- ▶ 厚度: 1.2mm
- ▶ 材质: SUS304

